



**DATOS MOTOR**

POTENCIA	1HP
REVOLUCIONES	1760
FRECUENCIA	60HZ
TORQUE MOTOR NOMINAL	4,1
CARCASA (PAM)	90(B5)
TIPO BRIDA	FF-165
EFICIENCIA MOTOR	IE 2

**DATOS REDUCTOR**

REFERENCIA	550016
TIPO	ORTOGONAL
MODELO	FCN
MATERIAL	ALUMINIO
CARCASA	75
RELACION DE TRANSMISION i:	50
VELOCIDAD SALIDA	35,20
TORQUE MAXIMO	212
TORQUE OPERACIÓN	141
FACTOR DE SERVICIO	1,5

**PLANOS REDUCTOR**

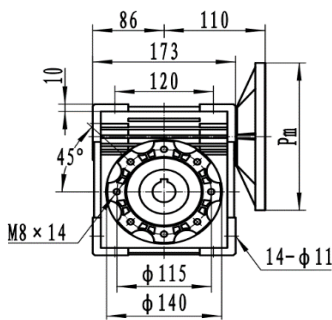

**FCN 75**

Input shaft hole

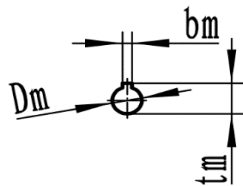

Output shaft hole

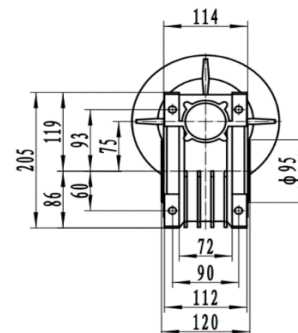
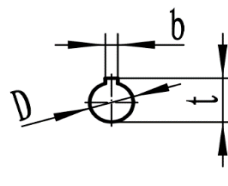

Dimensions of output shaft				
D	H7	b	D10	t
28		8		31.3

	Pm	Dm	bm	tm
71B5	160	14	5	16.3
80B5	200	19	6	21.8
80B14	120			
90B5	200	24	8	27.3
90B14	140			
100/112B5	250	28	8	31.3
100/112B14	160			